

PowerKiss Wire-free Charging Hotspot Positioning Guide

Contents

Summary of the requirements	3
PowerKiss wire-free charging	4
Ring	4
Heart	4
Processing	5
Technical requirements	6
I Furniture material	6
II Distance from the user	7
III Space required by PowerKiss Heart	8
IV Distance between two Hearts	9
Fine tuning the place for the Hotspot	10
I Optimal place for the Hotspot	10
II Taking adjacent seats into account	11
III The Edges	12
Examples of positioning the PowerKiss Hotspots	13
Round table with a diameter of 1,250mm	13
2,600mm x 1,060mm conference table	14
Single-user worktable with one Hotspot	15

Summary of the requirements

1. Furniture material requirements

Target surface thickness of 15-50 mm

Heat tolerant at 80°C

Not containing metal or other conductive material

2. Required distances (from center of the Hotspot)

From the user's body - vertically 250mm

From the user's body - horizontally 200mm

To another Hotspot 300mm

3. Reserve an area for the installation of the Heart around the Hotspot

4. Place the Hotspot so that it is in front and right of the user. Recommended: 400mm to the right of the center of the sitting position and 200mm from the edge of the piece of furniture

5. Do not place the Hotspot in an area meant for another user or near the edges of the surface

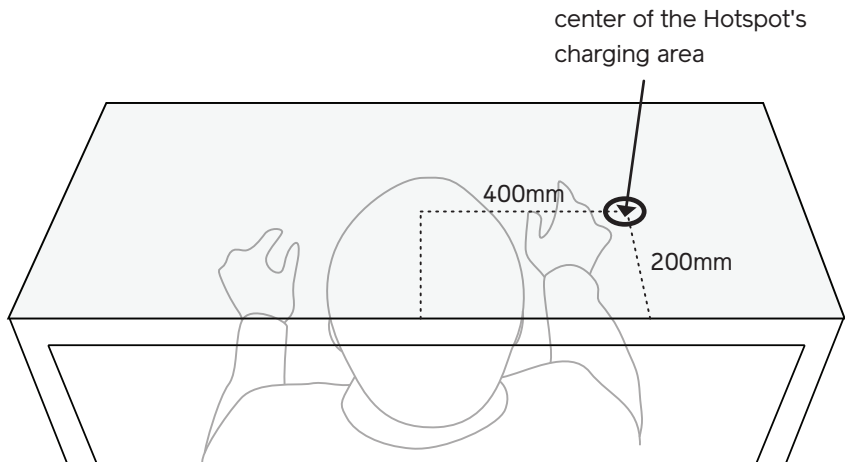

PowerKiss wire-free charging

The essence of wire-free charging is the pairing of Heart and Ring. The Heart is the transmitter and the Ring is the receiver and together they enable wire-free charging on almost any surface.

Ring

The Ring is a small accessory that is plugged into handheld devices, such as mobile phones or mp3-players. As soon as the Ring is plugged in, the device is ready to be a part of a wire-free energy transaction.

Heart

To turn a surface into a wire-free charging platform it first needs to be given a Heart. Like most, this Heart is also hidden except for a small LED light to indicate that it is ready to charge a mobile device wearing a Ring. The LED is also the center point of the charging area, called PowerKiss Hotspot. Whenever the device with Ring is on this Hotspot, the wire-free charging begins.

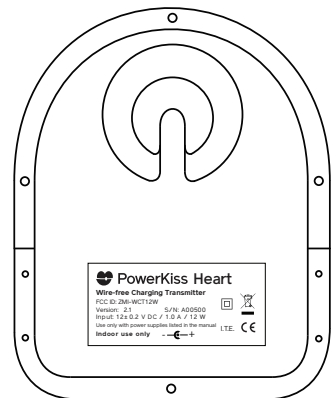
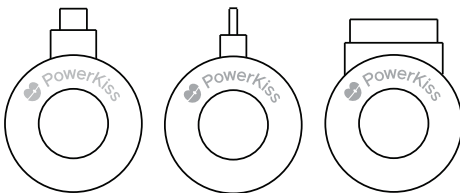

Processing

As was mentioned in the foreword, the Heart is installed to a piece of furniture.
There is a special milling that needs to be done in order to use the Heart properly.
Drawings of the milling are presented in pictures below.

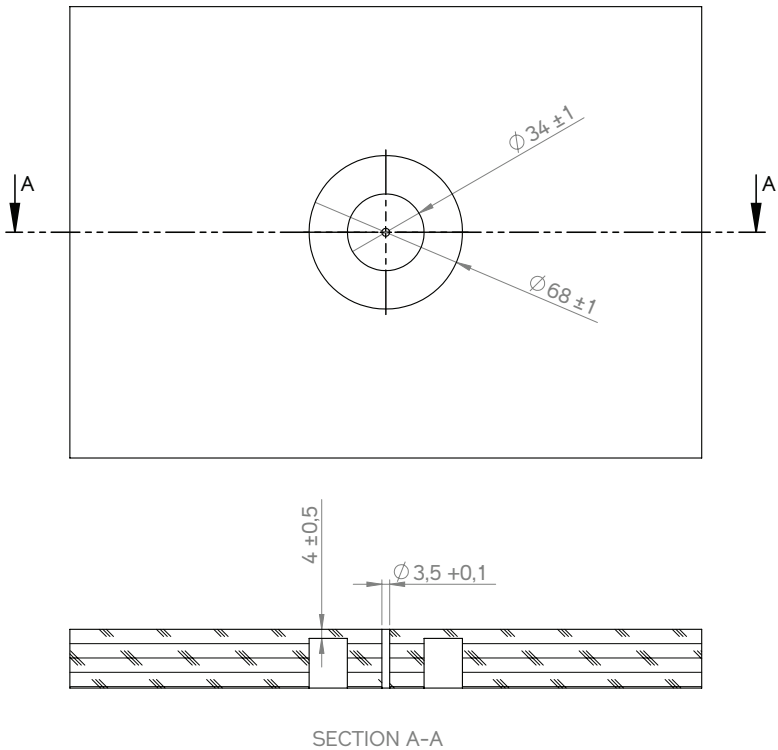

Technical requirements

I Furniture material

Due to the characteristics of electromagnetic fields, PowerKiss wire-free charging equipment should not be inserted into metal surfaces, or other conductive or highly magnetic materials.

Also, because of the heating of the PowerKiss Heart and Ring, the material in which the equipment is inserted, should be heat tolerant at 80°C. This applies also for the coating material of the surface.

The PowerKiss Heart is designed to be installed into a piece of furniture with surface thickness of 15-50mm.



Furniture material should be

- Heat tolerant at 80°C
- Target surface thickness of 15-50 mm
- Not containing metal or conductive material

II Distance from the user

Due to the characteristics of electromagnetic fields, PowerKiss Hotspot must not be positioned so that the center of the charging area is continuously closer than 250mm from the user's body in vertical direction and 200mm in horizontal direction.

This matter of attention applies to such special cases as special structures of pieces of furniture and solutions designed to be positioned to the immediate vicinity of the user.



Required distance between user and Hotspot

- 250mm in vertical direction
- 200mm in horizontal direction

III Space required by PowerKiss Heart

The installation of PowerKiss Heart requires a certain amount of space, which should be taken into account before the actual processing of the table.

One should also remember that Heart must finally be plugged into a power supply, which means that there must also be space for a power cable.

Heart dimensions

- Width: 132mm
- Length: 162mm
- Height: 24mm
- Weight: 135g

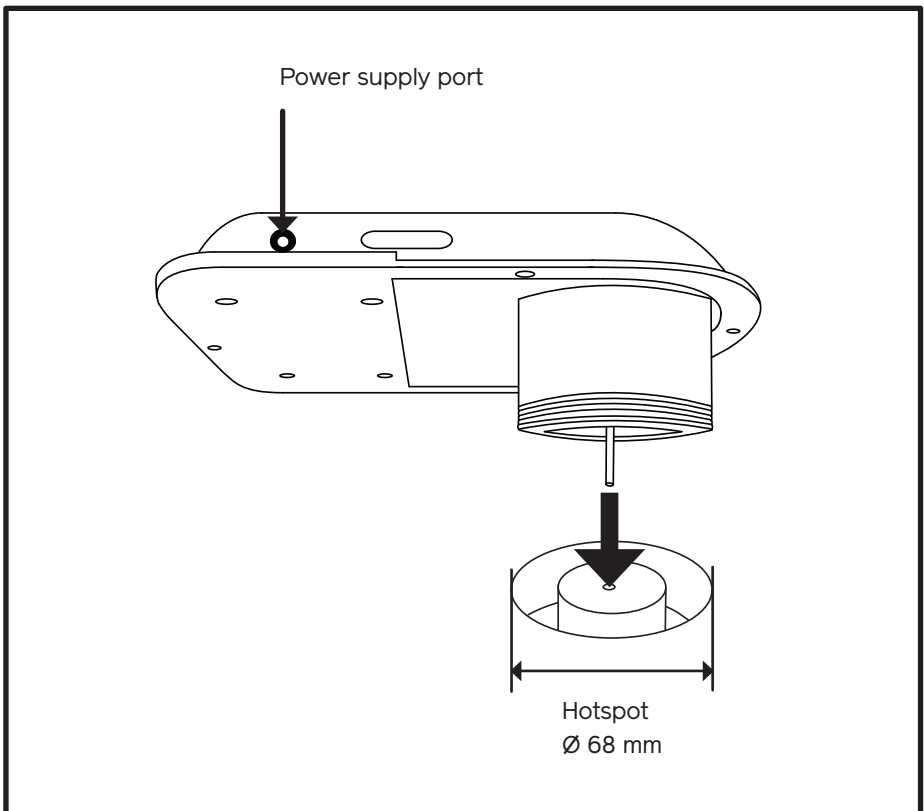

IV Distance between two Hearts

If the plan is to install several Hearts into a single surface, attention must be paid to their distance from each other. The distance between two Hearts must be at least 300mm. The distances should be measured from the center of the Hotspots.

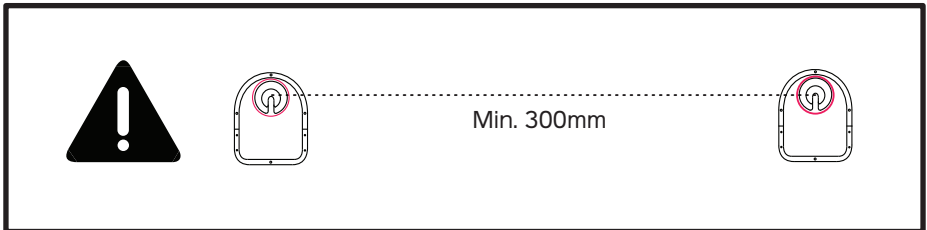

Fine tuning the place for the Hotspot

I Optimal place for the Hotspot

When it comes to tables, users usually place their small devices, such as mobile phones, to the right and front. The recommended centre position of the PowerKiss Hotspot is 400mm to the right of the sitting position and 200mm from the edge of the piece of furniture, as presented in image below.

The goal is to place the Hotspot in a position where the user can easily reach while also making sure that the area does not disturb the primary use of the table (such as eating or work).

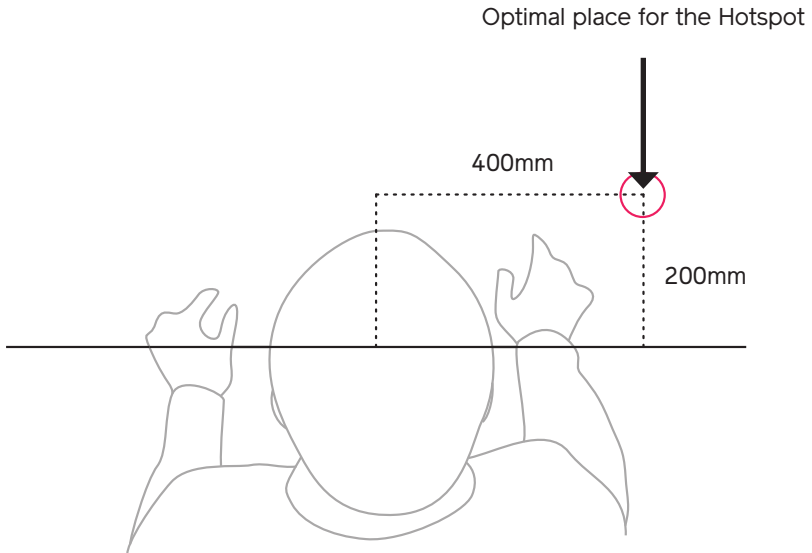

II Taking adjacent seats into account

Ensure that the Hotspots do not cross to the working areas of another users (in the area of another seating position),
If needed, change the distance so that the area will be closer to the centre of the seating position of the user for whom the area is being established.

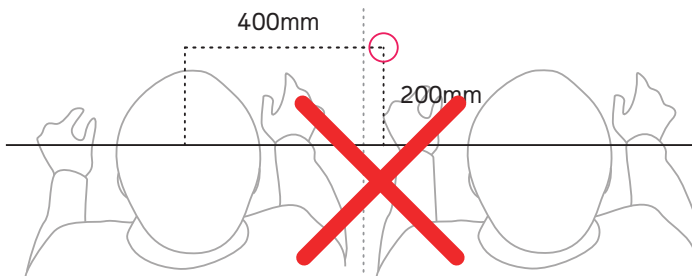
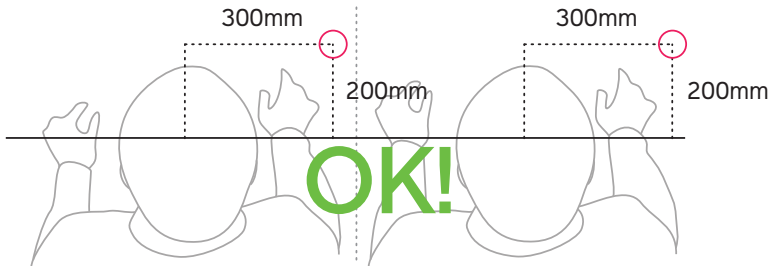

III The Edges

The centre of the Hotspot should be positioned so that there would be 200mm minimum distance from the edges, in order to avoid dropping the devices being charged and to ensure distance between the user and the Hotspot (see page 7).

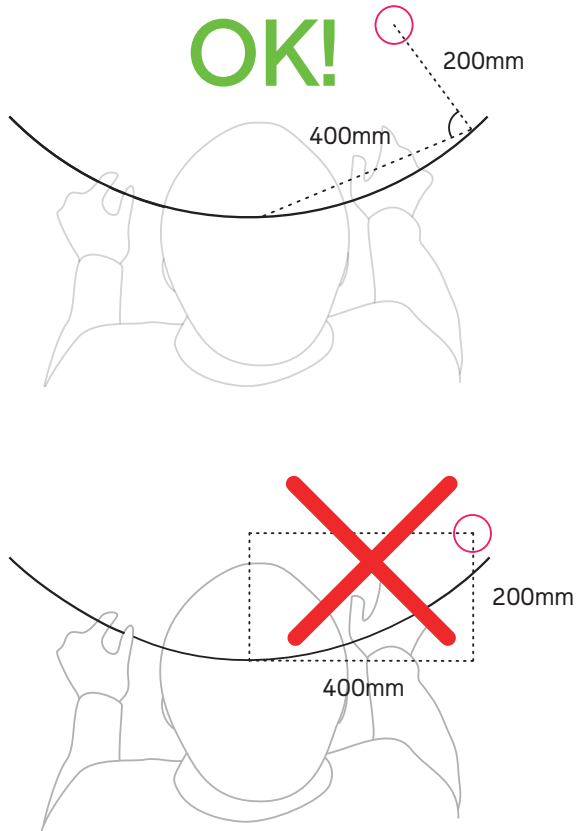

Examples of positioning the PowerKiss Hotspots

There are a few examples below of tables of different shapes and types and related examples of Hotspot positioning.

There are various matters that affect the design of a Hotspot positioning. These include aesthetics, materials, usage and manufacturing procedures. One should always remember that without a proper positioning, the piece of furniture fails to provide its feature of wire-free charging.

Round table with a diameter of 1,250mm

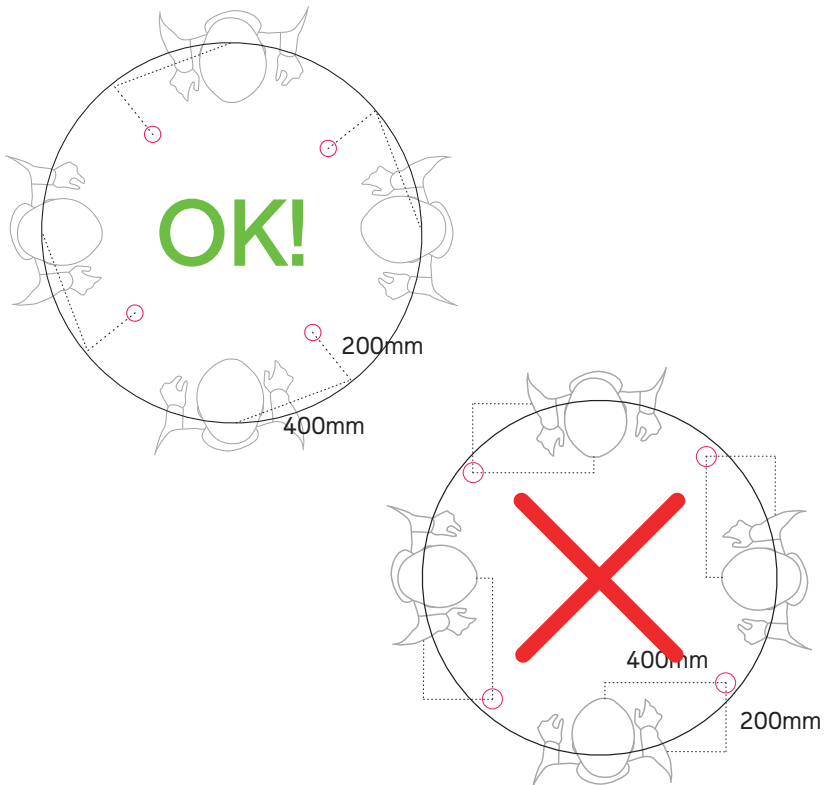

2,600mm x 1,060mm conference table with two shared Hotspots

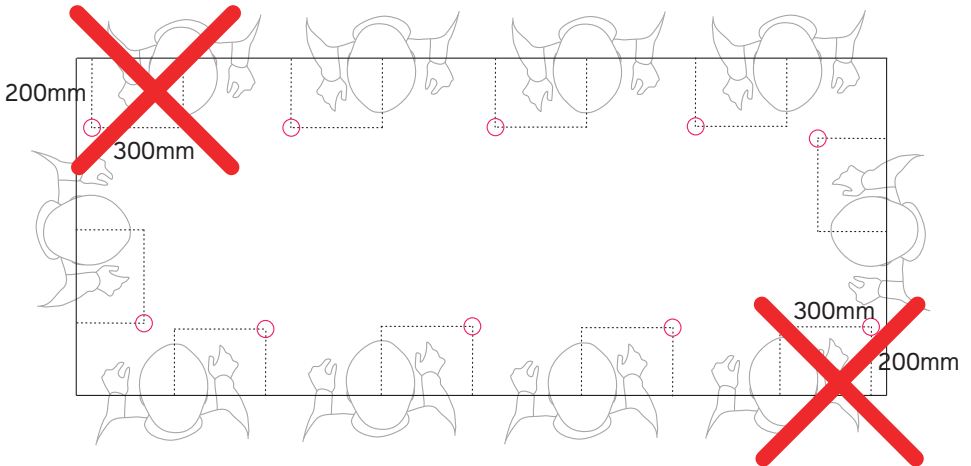
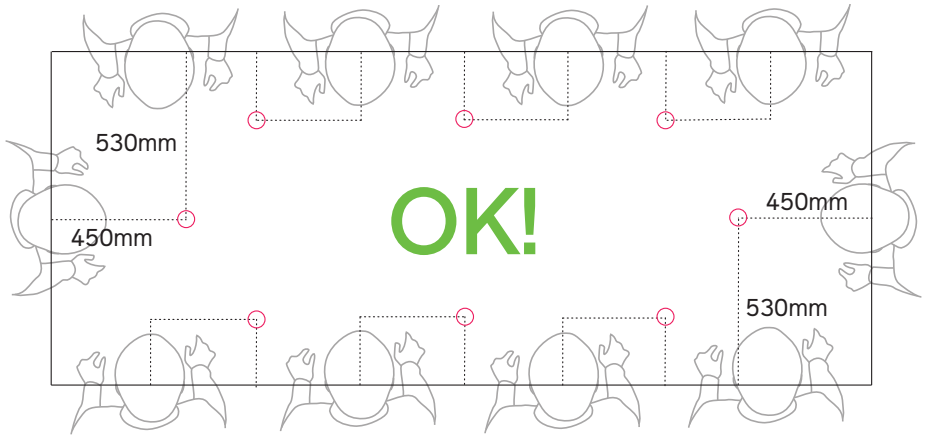

Single-user worktable with one Hotspot,
dimensions: 2,000mm x 2,500cm

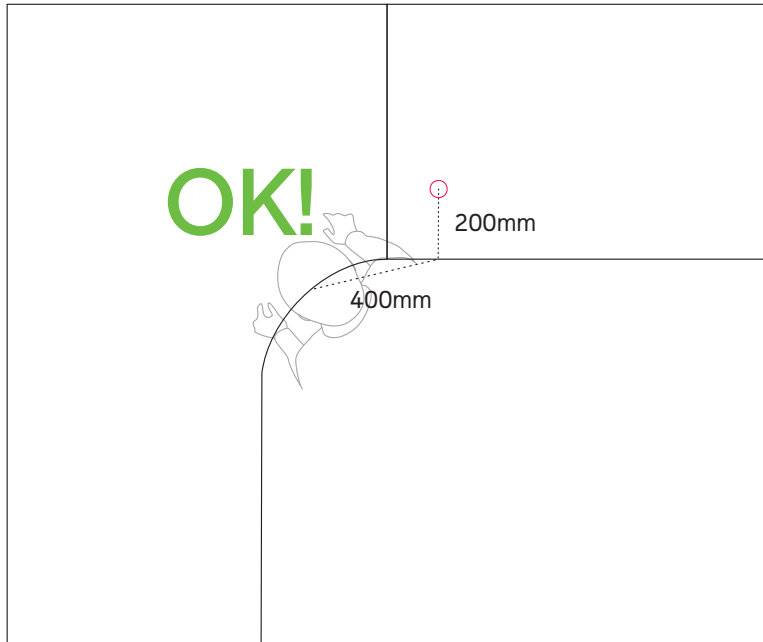

Design
and
technology

are matters
of Heart